

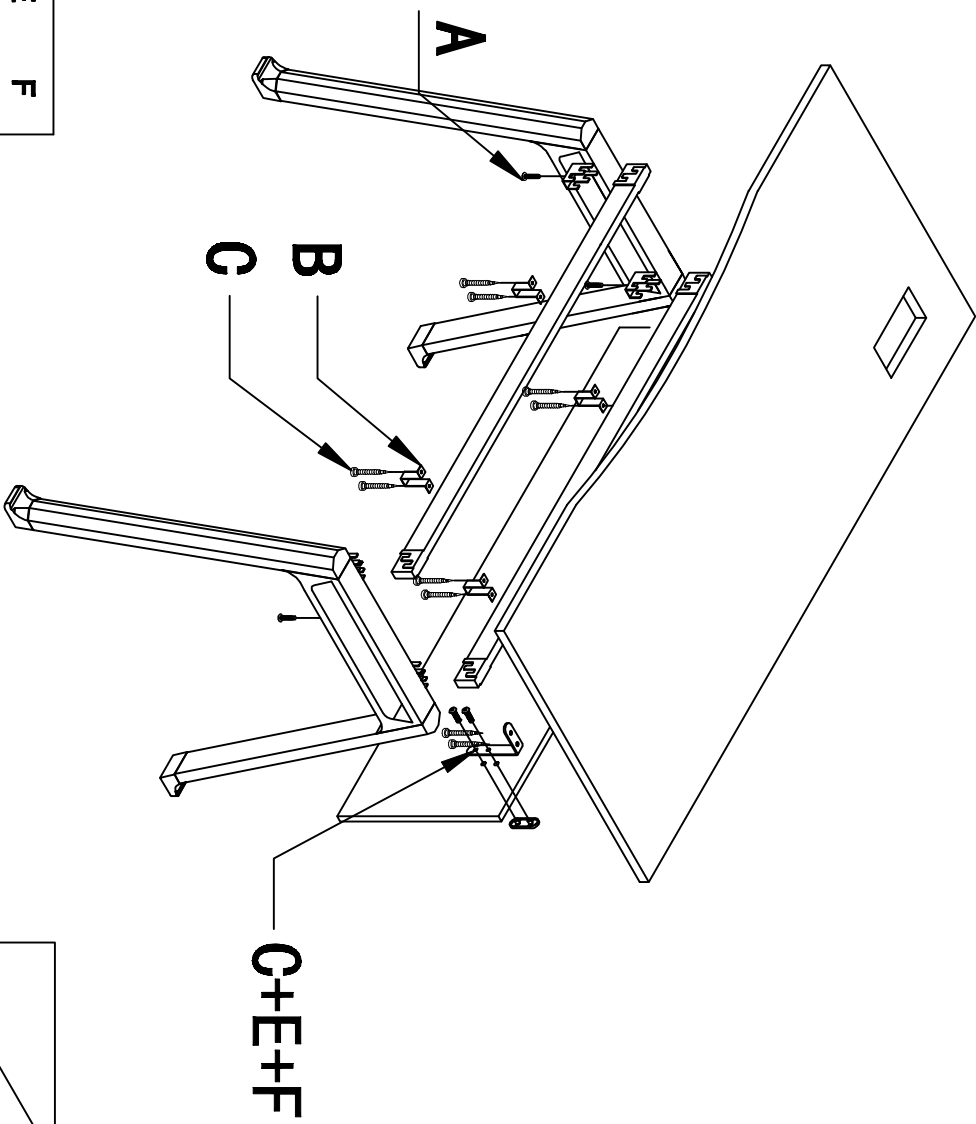

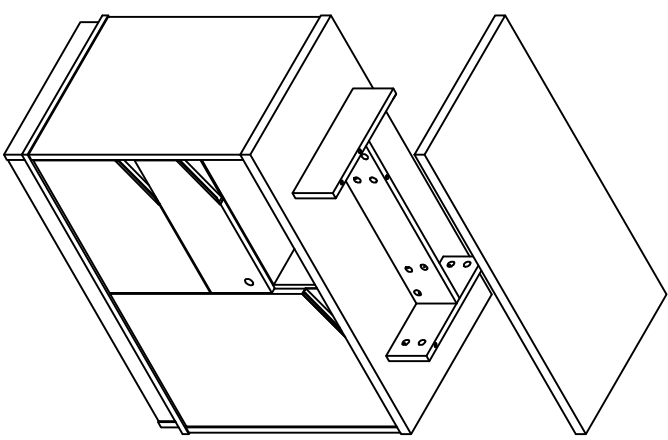



ASSEMBLE INSTRUCTION

TR-142



No.	A	B	C	D	E	F
PARTS LIST						
	M6*10		M4x16	4#		M6*16
	4	6	28	1	2	4
	QTY					

